

**MODEL 05106**  
**WIND MONITOR-MA**



MAY 2001



**CAMPBELL SCIENTIFIC**

CANADA CORP.

11564 - 149 street - edmonton - alberta - T5M 1W7  
tel 780.454.2505 fax 780.454.2655

[www.campbellsci.ca](http://www.campbellsci.ca)



## WARRANTY AND ASSISTANCE

**R.M. YOUNG PRODUCTS** are warranted by **CAMPBELL SCIENTIFIC (CANADA) CORP.** ("CSC") to be free from defects in materials and workmanship under normal use and service for **twelve (12) months** from date of shipment unless specified otherwise. CSC's obligation under this warranty is limited to repairing or replacing (at CSC's option) defective products. The customer shall assume all costs of removing, reinstalling, and shipping defective products to CSC. CSC will return such products by surface carrier prepaid. This warranty shall not apply to any CSC products which have been subjected to modification, misuse, neglect, accidents of nature, or shipping damage. This warranty is in lieu of all other warranties, expressed or implied, including warranties of merchantability or fitness for a particular purpose. CSC is not liable for special, indirect, incidental, or consequential damages.

Products may not be returned without prior authorization. To obtain a Return Merchandise Authorization (RMA), contact **CAMPBELL SCIENTIFIC (CANADA) CORP.**, at (780) 454-2505. An RMA number will be issued in order to facilitate Repair Personnel in identifying an instrument upon arrival. Please write this number clearly on the outside of the shipping container. Include description of symptoms and all pertinent details.

**CAMPBELL SCIENTIFIC (CANADA) CORP.** does not accept collect calls.

Non-warranty products returned for repair should be accompanied by a purchase order to cover repair costs.



**CAMPBELL SCIENTIFIC**  
CANADA CORP.

11564 - 149 street - edmonton - alberta - T5M 1W7  
tel 780.454.2505 fax 780.454.2655

[www.campbellsci.ca](http://www.campbellsci.ca)





## MODEL 05106 WIND MONITOR-MA

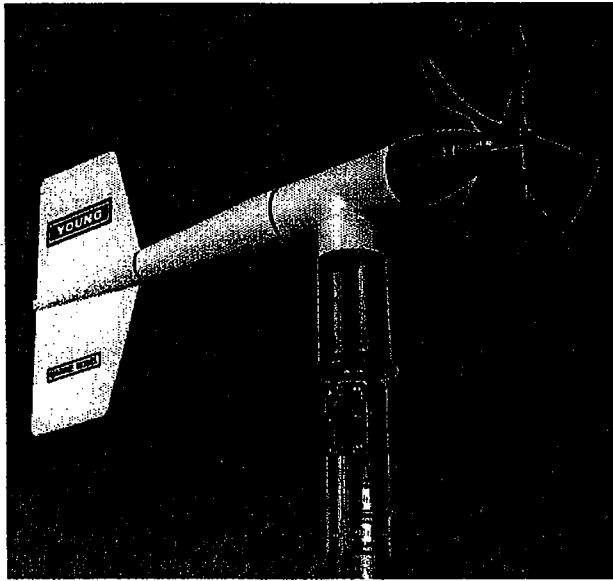

### WIND SPEED SPECIFICATION SUMMARY:

Range	0 to 60 m/s (130 mph), gust survival 100 m/s (220 mph)
Sensor	18 cm diameter 4-blade helicoid propeller molded of polypropylene
Pitch	29.4 cm air passage per revolution
Distance Constant	2.7 m (8.9 ft.) for 63% recovery
Threshold Sensitivity	1.1 m/s (2.4 mph)
Transducer	Centrally mounted stationary coil, 2K Ohm nominal DC resistance
Transducer Output	AC sine wave signal induced by rotating magnet on propeller shaft. 125 mV p-p at 100 rpm. 12.5 V p-p at 10,000 rpm.
Output Frequency	3 cycles per propeller revolution (0.098 m/s per Hz)

### WIND DIRECTION (AZIMUTH) SPECIFICATION SUMMARY:

Range	360° mechanical, 355° electrical (5° open)
Sensor	Balanced vane, 38 cm (15 in) turning radius.
Damping Ratio	0.25
Delay Distance	1.3 m (4.3 ft) for 50% recovery
Threshold Sensitivity	1.1 m/s (2.4 mph) at 10° displacement
Damped Natural Wavelength	7.4 m (24.3 ft)
Undamped Natural Wavelength	7.2 m (23.6 ft)
Transducer	Precision conductive plastic potentiometer, 10K ohm resistance ( $\pm 20\%$ ), 0.25% linearity, life expectancy 50 million revolutions, rated 1 watt at 40° C, 0 watts at 125° C
Transducer Excitation Requirement	Regulated DC voltage, 15 VDC max
Transducer Output	Analog DC voltage proportional to azimuth angle with regulated excitation voltage applied across potentiometer.

### GENERAL

Operating Temperature: -50 to 50°C (-58 to 122°F)

### INTRODUCTION

The Wind Monitor-MA-MA measures horizontal wind speed and direction. Originally developed for ocean data buoy use, it is rugged and corrosion resistant yet accurate and light weight. The main housing, nose cone, propeller, and other internal parts are injection molded U.V. stabilized plastic. Both the propeller and vertical shafts use stainless steel precision grade ball bearings. Bearings have light contacting teflon seals and are filled with a low torque wide temperature range grease to help exclude contamination and moisture.

Propeller rotation produces an AC sine wave signal with frequency proportional to wind speed. This AC signal is induced in a stationary coil by a six pole magnet mounted on the propeller shaft. Three complete sine wave cycles are produced for each propeller revolution.

Vane position is transmitted by a 10K ohm precision conductive plastic potentiometer which requires a regulated excitation voltage. With a constant voltage applied to the potentiometer, the output signal is an analog voltage directly proportional to azimuth angle.

The instrument mounts on standard one inch pipe, outside diameter 34 mm (1.34"). An orientation ring is provided so the instrument can be removed for maintenance and reinstalled without loss of wind direction reference. Both mounting post assembly and orientation ring are secured to the mounting pipe by stainless steel band clamps. A 1 meter (3.3 ft) pigtail cable assembly is supplied for electrical connections. For longer cable lengths a user supplied junction box or connector may be used. A variety of devices are available for signal conditioning, display, and recording of wind speed and direction.

### INITIAL CHECKOUT

When the Wind Monitor-MA is unpacked it should be checked carefully for any signs of shipping damage. Remove the plastic nut on the propeller shaft. Install the propeller on the shaft so the letter markings on the propeller face forward (into the wind). Engage the propeller into the molded ribs on the propeller shaft hub. The instrument is aligned, balanced and fully calibrated before shipment, however it should be checked both mechanically and electrically before installation. The vane and propeller should easily rotate 360° without friction. Check vane balance by holding the instrument base so the vane surface is horizontal. It should have near neutral torque without any particular tendency to rotate. A slight imbalance will not degrade performance.

The potentiometer requires a stable DC excitation voltage. Do not exceed 15 volts. When the potentiometer wiper is in the 5° deadband region, the output signal is "floating" and may show varying or unpredictable values. To prevent false readings, signal conditioning electronics should clamp the signal to excitation or reference level when this occurs. **NOTE: Young signal conditioning devices clamp the signal to excitation level.** Avoid a short circuit between the azimuth signal line and either the excitation or reference lines. Although there is a 1K ohm current limiting resistor in series with the wiper for protection, damage to the potentiometer may occur if a short circuit condition exists.

Before installation, connect the instrument to an indicator as shown in the wiring diagram and check for proper wind speed and azimuth values. Position the vane over a sheet of paper with 30° or 45° crossmarkings to check vane alignment. To check wind speed, temporarily remove the propeller and connect the shaft to an Anemometer Drive. Details appear in the CALIBRATION section of this manual.

- e) Tighten mounting post band clamp.
- f) Engage orientation ring indexing pin in notch at instrument base.
- g) Tighten orientation ring band clamp.

## INSTALLATION

Proper placement of the instrument is very important. Eddies from trees, buildings, or other structures can greatly influence wind speed and wind direction observations. To get meaningful data for most applications locate the instrument well above or upwind from obstructions. As a general rule, the air flow around a structure is disturbed to twice the height of the structure upwind, six times the height downwind, and up to twice the height of the structure above ground. For some applications it may not be practical or necessary to meet these requirements.

### FAILURE TO PROPERLY GROUND THE WIND MONITOR-MA MAY RESULT IN ERRONEOUS SIGNALS OR TRANSDUCER DAMAGE.

Grounding the Wind Monitor-MA is vitally important. Without proper grounding, static electrical charge can build up during certain atmospheric conditions and discharge through the transducers. This discharge can potentially cause erroneous signals or transducer failure. To direct the discharge away from the transducers, the mounting post assembly in which the transducers are mounted is made with a special antistatic plastic. The Wind Monitor-MA should be mounted on a metal pipe which is connected to earth ground. The mounting pipe should not be painted where the Wind Monitor-MA is mounted. Towers or masts set in concrete should be connected to one or more grounding rods.

If it is difficult to ground the mounting post in this manner, the following method should be used. The sensor cable shield wire is internally connected to the antistatic mounting post. This shield wire should be connected to an earth ground. (Refer to wiring diagram)

Initial installation is most easily done with two people; one to adjust the instrument position and the other to observe the indicating device. After initial installation, the instrument can be removed and returned to its mounting without realigning the vane since the orientation ring preserves the wind direction reference. Install the Wind Monitor-MA following these steps:

1. MOUNT WIND MONITOR-MA
  - a) Place orientation ring on mounting post. Do Not tighten band clamp yet.
  - b) Place Wind Monitor-MA on mounting post. Do Not tighten band clamp yet.
2. CONNECT SENSOR CABLE
  - a) Route cable carefully to avoid strain.
  - b) Use of a waterproof connector or junction box is recommended.
3. ALIGN VANE
  - a) Connect instrument to an indicator.
  - b) Choose a known wind direction reference point on the horizon.
  - c) Sighting down instrument centerline, point nose cone at reference point on horizon.
  - d) While holding vane in position, slowly turn base until indicator shows proper value.

## CALIBRATION

The Wind Monitor-MA is fully calibrated before shipment and should require no adjustments. Recalibration may be necessary after some maintenance operations. Periodic calibration checks are desirable and may be necessary where the instrument is used in programs which require auditing of sensor performance.

Accurate wind direction calibration requires a Model 18112 Vane Angle Bench Stand. Begin by connecting the instrument to a signal conditioning circuit which has some method of indicating azimuth value. This may be a display which shows azimuth values in angular degrees or simply a voltmeter monitoring the output. Orient the base with the junction box at 180°. Visually align the vane with the crossmarkings and observe the indicator output. If the vane position and indicator do not agree within 5°, adjust the potentiometer coupling inside the main housing. Details for making this adjustment appear in the MAINTENANCE, potentiometer replacement outline, step 7. It is important to note that while full scale azimuth on signal conditioning electronics may be 360°, full scale azimuth signal from the instrument is 355°. The signal conditioning electronics must be adjusted accordingly. For example, in a circuit where 0 to 1.000 VDC represents 0° to 360°, the output must be adjusted for 0.986 VDC when the instrument is at 355°. ( $355°/360° \times 1.000 \text{ volts} = 0.986 \text{ volts}$ )

Wind speed calibration is determined by propeller pitch and the output characteristics of the transducer. Calibration formulas showing wind speed vs. propeller rpm and output frequency are included below. Standard accuracy is  $\pm 0.3 \text{ m/s}$  (0.6mph). For greater accuracy, the device must be individually calibrated in comparison with a wind speed standard. Contact the factory or your supplier to schedule a NIST (National Institute of Standards & Technology) traceable wind tunnel calibration in our factory.

To calibrate wind system electronics using a signal from the instrument, temporarily remove the propeller and connect an Anemometer Drive to the propeller shaft. Apply the appropriate calibration formula to the calibrating motor rpm and adjust the electronics for the proper value. For example, with the propeller shaft turning at 3600 rpm adjust an indicator to display 17.6 meters per second ( $3600 \text{ rpm} \times 0.00490 \text{ m/s/rpm} = 17.6 \text{ m/s}$ ).

### CALIBRATION FORMULAS

#### Model 05106 Wind Monitor-MA w/ 08234 Propeller

WIND SPEED vs PROPELLER RPM	
m/s	= 0.00490 x rpm
knots	= 0.00952 x rpm
mph	= 0.01096 x rpm
km/h	= 0.01764 x rpm

WIND SPEED vs OUTPUT FREQUENCY	
m/s	= 0.0980 x Hz
knots	= 0.1904 x Hz
mph	= 0.2192 x Hz
km/h	= 0.3528 x Hz

## **MAINTENANCE**

Given proper care, the Wind Monitor-MA should provide years of service. The only components likely to need replacement due to normal wear are the precision ball bearings and the wind direction potentiometer. Only a qualified instrument technician should perform the replacement. If service facilities are not available, return the instrument to the company. Refer to the drawings to become familiar with part names and locations. The asterisk\* which appears in the following outlines is a reminder that maximum torque on all set screws is 80 oz-in.

### **POTENTIOMETER REPLACEMENT:**

The potentiometer has a life expectancy of fifty million revolutions. As it becomes worn, the element may begin to produce noisy signals or become nonlinear. When signal noise or non-linearity becomes unacceptable, replace the potentiometer. Refer to exploded view drawing and proceed as follows:

#### **1. REMOVE MAIN HOUSING**

- a) Unscrew nose cone from main housing. Set o-ring aside for later use.
- b) Remove 4 screws attaching housing.
- c) Gently push main housing latch.
- d) While pushing latch, lift main housing up and remove it from vertical shaft bearing rotor.

#### **2. UNSOLDER TRANSDUCER WIRES**

- a) Remove screws securing cable and strain relief assembly to mounting post.
- b) Slowly pull strain relief away from mounting post exposing circuit board with transducer wire connections.

#### **3. REMOVE POTENTIOMETER**

- a) Loosen set screw on potentiometer coupling and remove it from potentiometer adjust thumbwheel.
- b) Loosen set screw on potentiometer adjust thumbwheel and remove it from potentiometer shaft extension.
- c) Loosen two set screws at base of transducer assembly and remove assembly from vertical shaft.
- d) Unscrew potentiometer housing from potentiometer mounting & coil assembly.
- e) Push potentiometer out of potentiometer mounting & coil assembly by applying firm but gentle pressure on potentiometer shaft extension. Set o-ring aside for later use.
- f) Loosen set screw on potentiometer shaft extension and remove it from potentiometer shaft.

#### **4. INSTALL NEW POTENTIOMETER**

- a) Place potentiometer shaft extension with o-ring on new potentiometer (Gap 0.040") and tighten set screw\*. Regrease o-ring if necessary.
- b) Push new potentiometer into potentiometer mounting & coil assembly.
- c) Feed potentiometer and coil wires through hole in bottom of potentiometer housing.
- d) Screw potentiometer housing onto potentiometer mounting & coil assembly.
- e) Gently pull transducer wires through bottom of potentiometer housing to take up any slack. Apply a small amount of silicone sealant around hole.
- f) Install transducer assembly on vertical shaft allowing 0.5 mm (0.020") clearance from bearing. Tighten set screws\* at bottom of transducer assembly.
- g) Place potentiometer adjust thumbwheel on potentiometer shaft extension and tighten set screw\*.
- h) Place potentiometer coupling on potentiometer adjust thumbwheel. Do Not tighten set screw yet.

\*Max set screw torque 80 oz-in

#### **5. RECONNECT TRANSDUCER WIRES**

- a) Using needle-nose pliers or a paper clip bent to form a small hook, gently pull transducer wires through hole in mounting post.
- b) Solder wires to cable assembly. Apply small amount of silicone sealant to solder connections. Observe color code.
- c) Secure cable & strain relief assembly removed in step 2A.

#### **6. REPLACE MAIN HOUSING**

- a) Place main housing over vertical shaft bearing rotor. Be careful to align indexing key and channel in these two assemblies.
- b) Place main housing over vertical shaft bearing rotor until potentiometer coupling is near top of main housing.
- c) Turn potentiometer adjust thumbwheel until potentiometer coupling is oriented to engage ridge in top of main housing. Set screw on potentiometer coupling should be facing the front opening.
- d) With potentiometer coupling properly oriented, continue pushing main housing onto vertical shaft bearing rotor until main housing latch locks into position with a "click".
- e) Replace 4 screws.

#### **7. ALIGN VANE**

- a) Connect excitation voltage and signal conditioning electronics to terminal strip according to wiring diagram.
- b) With mounting post held in position so junction box is facing due south, orient vane to a known angular reference. Details appear in CALIBRATION section.
- c) Reach in through front of main housing and turn potentiometer adjust thumbwheel until signal conditioning system indicates proper value.
- d) Tighten set screw\* on potentiometer coupling.

#### **8. REPLACE NOSE CONE**

- a) Screw nose cone into main housing until o-ring seal is seated. Be certain threads are properly engaged to avoid cross-threading.

### **FLANGE BEARING REPLACEMENT:**

If anemometer bearings become noisy or wind speed threshold increases above an acceptable level, bearings may need replacement. Check anemometer bearing condition using a Model 18310 Propeller Torque Disc. Without it, a rough check can be performed by adding an ordinary paper clip (0.5 gm) to the tip of a propeller blade. Turn the blade with the paper clip to the "three o'clock" or "nine o'clock" position and gently release it. Failure to rotate due to the weight of the paper clip indicates anemometer bearings need replacement. Repeat this test at different positions to check full bearing rotation. If needed, bearings are replaced as follows.

#### **1. REMOVE OLD BEARINGS**

- a) Unscrew nose cone. Do not lose o-ring seal.
- b) Loosen set screw on magnet shaft collar and remove magnet.
- c) Slide propeller shaft out of nose cone assembly.
- d) Remove front bearing cap which covers front bearing.
- e) Remove both front and rear bearings from nose cone assembly. Insert edge of a pocket knife under bearing flange and lift it out.

#### **2. INSTALL NEW BEARINGS**

- a) Insert new front and rear bearings into nose cone.
- b) Replace front bearing cap.
- c) Carefully slide propeller shaft through bearings.
- d) Place magnet on propeller shaft allowing 0.5 mm (0.020") clearance from rear bearing.

- e) Tighten set screw\* on magnet shaft collar.
- f) Screw nose cone into main housing until o-ring seal is seated. Be certain threads are properly engaged to avoid cross-threading.

**VERTICAL SHAFT BEARING REPLACEMENT:**

Vertical shaft bearings are much larger than the anemometer bearings. Ordinarily, these bearings will require replacement less frequently than anemometer bearings. Check bearing condition using a Model 18331 Vane Torque Gauge. Without it, a rough check can be performed by holding the instrument with the vane horizontal and placing a 3 gm weight near the aft edge of the fin. A U.S. penny weighs about 3 gm and is convenient for this check. Failure to rotate downward indicates the vertical bearings need replacement. Repeat this test at different positions to check full bearing rotation.

Since this procedure is similar to POTENTIOMETER REPLACEMENT, only the major steps are listed here.

1. REMOVE MAIN HOUSING
2. UNSOLDER TRANSDUCER WIRES AND REMOVE TRANSDUCER ASSEMBLY  
Loosen set screws at base of transducer assembly and remove entire assembly from vertical shaft.
3. REMOVE VERTICAL SHAFT BEARING ROTOR by sliding it upward off vertical shaft.
4. REMOVE OLD VERTICAL BEARINGS AND INSTALL NEW BEARINGS. When inserting new bearings, be careful not to apply pressure to bearing shields.
5. REPLACE VERTICAL SHAFT BEARING ROTOR.
6. REPLACE TRANSDUCER & RECONNECT WIRES
7. REPLACE MAIN HOUSING
8. ALIGN VANE
9. REPLACE NOSE CONE

**WARRANTY**

This product is warranted to be free of defects in materials and construction for a period of 12 months from date of initial purchase. Liability is limited to repair or replacement of defective item. A copy of the warranty policy may be obtained from R. M. Young Company.

**CE COMPLIANCE**

This product has been tested and shown to comply with European CE requirements for the EMC Directive. Please note that shielded cable must be used.

<b>Declaration of Conformity</b>
<b>Application of Council Directives:</b> 89/336/EEC
<b>Standards to which Conformity is Declared:</b> EN 50082-1 (IEC 801-2, 3, 4)
<b>Manufacturer's Name and Address:</b> R. M. Young Company Traverse City, MI, 49686, USA
<b>Importer's Name and Address:</b> See Shipper or Invoice
<b>Type of Equipment:</b> Meteorological Instruments
<b>Model Number / Year of Manufacture:</b> 05106/1996
I, the undersigned, hereby declare that the equipment specified conforms to the above Directives and Standards.
<b>Date / Place:</b> Traverse City, Michigan, USA February 19, 1996

David Poinsett R & D Manager, R. M. Young Company



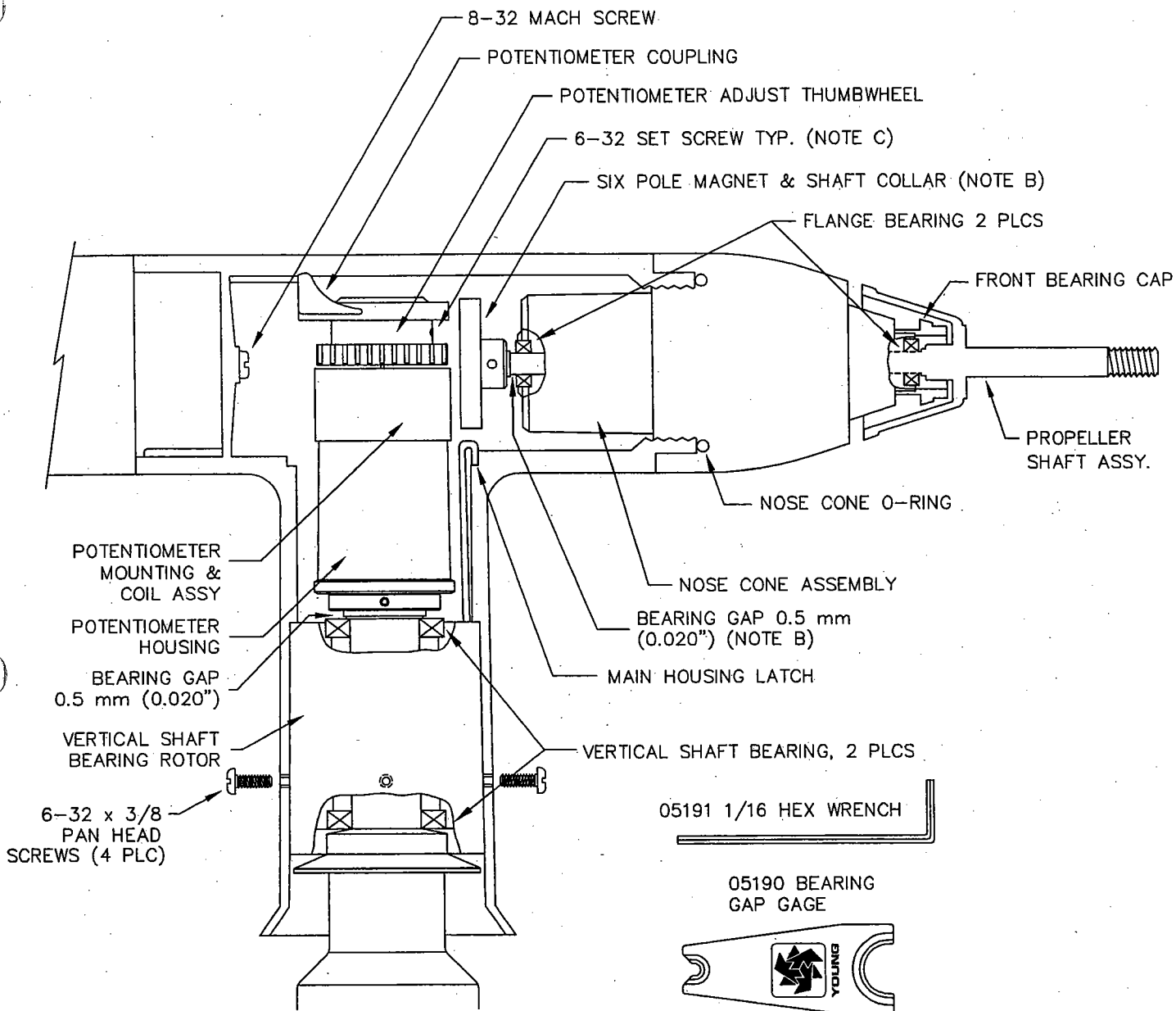

# WIND MONITOR-MA SECTION VIEW

## BEARING REPLACEMENT/POTENTIOMETER ADJUSTMENT



### NOTES:

- A. TO REMOVE MAIN HOUSING - UNTHREAD NOSE CONE ASSEMBLY, REMOVE HOUSING SCREWS, PUSH MAIN HOUSING LATCH, LIFT UPWARD.
- B. TO REPLACE ANEMOMETER FLANGE BEARINGS - UNTHREAD NOSE CONE, REMOVE SIX POLE MAGNET, SLIDE PROPELLER SHAFT AND HUB ASSEMBLY FORWARD, REMOVE FRONT BEARING CAP, AND FLANGE BEARINGS. AFTER BEARING REPLACEMENT, SET BEARING GAP TO 0.5mm (0.020")
- C. TO ADJUST POTENTIOMETER OUTPUT SIGNAL - REMOVE NOSE CONE, LOOSEN SET SCREW IN POTENTIOMETER COUPLING, ADJUST OUTPUT SIGNAL BY MEANS OF POTENTIOMETER ADJUSTMENT THUMBWHEEL, RE-TIGHTEN SET SCREW.

MODEL 05106 WIND MONITOR-MA	DWG A	PRD 08-00
SECTION VIEW - BEARING REPLACEMENT/ POTENTIOMETER ADJUSTMENT.	DWN KL	DWG 08-00
	CHK <i>Y.e.</i>	M05106M
R.M. YOUNG CO. TRAVERSE CITY, MI 49686 U.S.A. 231-946-3980		



MODEL 05106  
WIND MONITOR-MA/MARINE MODEL (CAMPBELL CANADA)

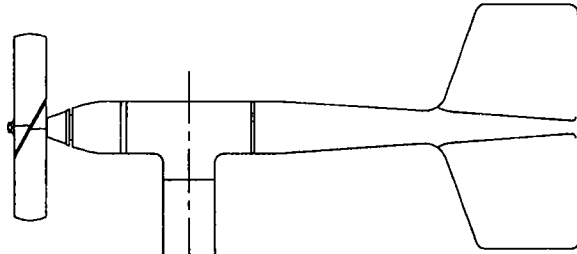

STATIONARY WIND SPEED TRANSDUCER COIL:

ROTATING MAGNET ON PROPELLER SHAFT INDUCES AC SIGNAL WITH FREQUENCY DIRECTLY PROPORTIONAL TO WIND SPEED. THREE CYCLES OF OUTPUT REPRESENT ONE PROPELLER ROTATION.

WIND DIRECTION POTENTIOMETER

10K OHMS, 0.25% LINEARITY, 355° FUNCTION ANGLE  
1 WATT @ 40° C, DERATED TO 0 WATTS @ 125° C

SIX POLE PERMANENT MAGNET MOUNTED ON PROPELLER SHAFT

IMPORTANT - THE WIND MONITOR MOUNTING MUST BE EARTH GROUNDED.

NOTE: POTENTIOMETER WIRES ARE 28 AWG. WIND SPEED COIL WIRES ARE 22 AWG

PC BOARD LOCATED IN MOUNTING POST

MULTI-CONDUCTOR CABLE  
3 PAIR SHIELDED, 22 AWG  
MODEL NO. 18721

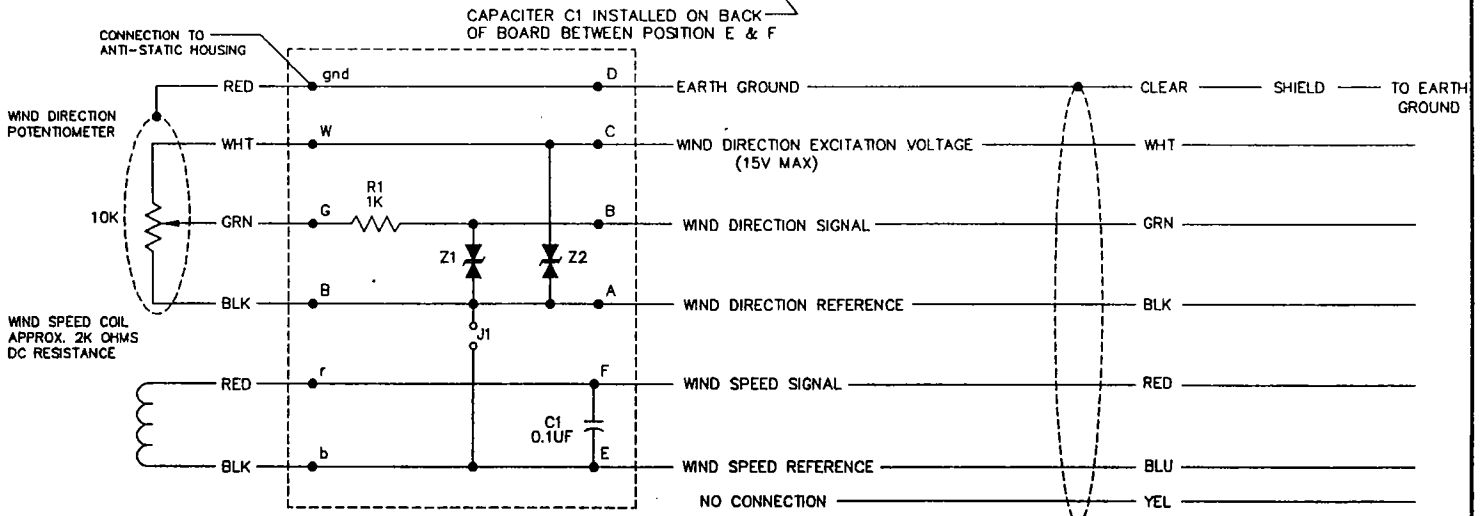
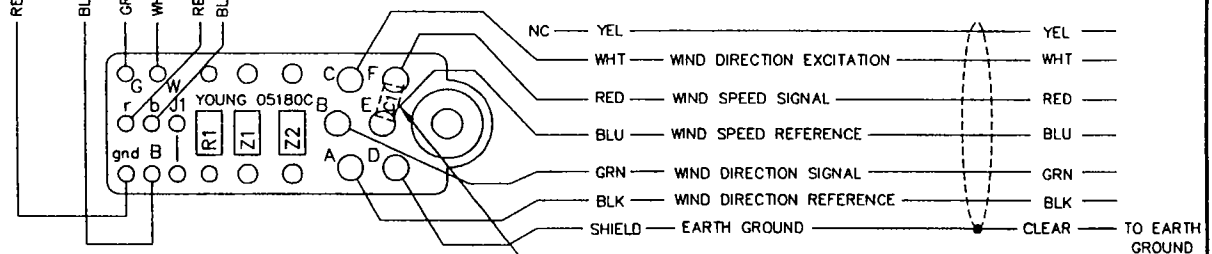

Z1 AND Z2 ARE TRANSZORB TRANSIENT PROTECTION DEVICES.

MODEL 05106	WIND MONITOR-MA	DWG A	PRD 04-98
MARINE MODEL (CAMPBELL CANADA)		DWN JMT	DWG 05-01
CABLE & WIRING DIAGRAM		CHK Y.C.	W05106-10B
R.M. YOUNG CO. TRAVERSE CITY, MI 49686 U.S.A. 231-946-3980			



MODEL 05106

WIND MONITOR-MA/MARINE MODEL WIND SENSOR (CAMPBELL CANADA)

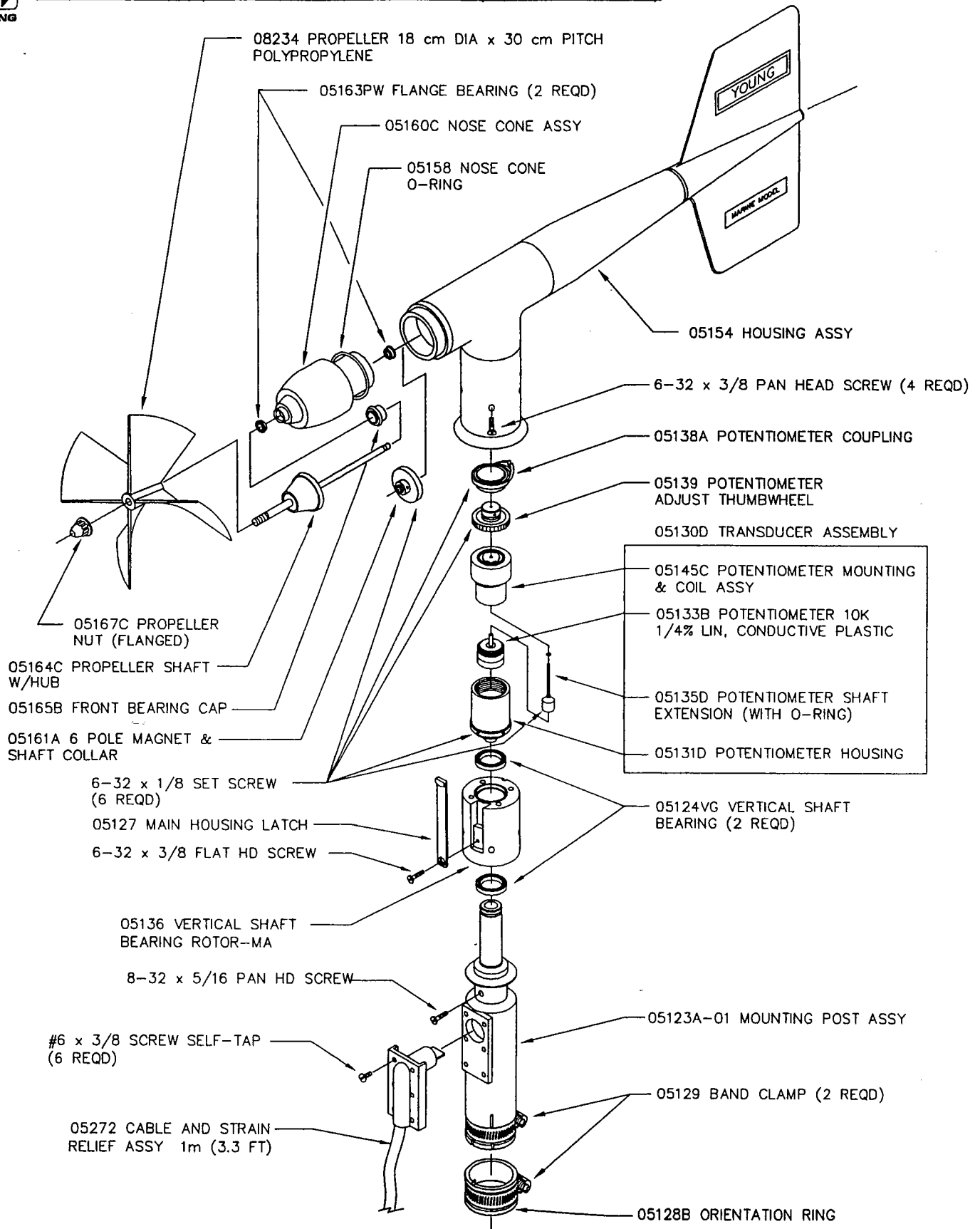

MODEL 05106	WIND MONITOR-MA	DWG A	PRD 01-94
MARINE MODEL (CAMPBELL CANADA)		DWN JMT	DWG 05-01
GENERAL ASSY & REPLACEMENT PARTS		CHK <i>[Signature]</i>	EQ05106-10B
R.M. YOUNG CO. TRAVERSE CITY, MI 49686 U.S.A. 231-946-3980			



# Calibration Accessories

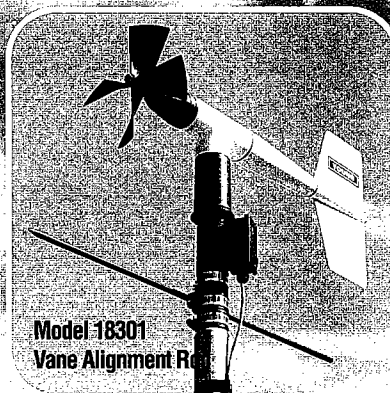
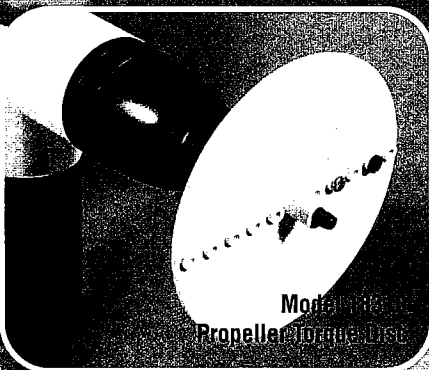
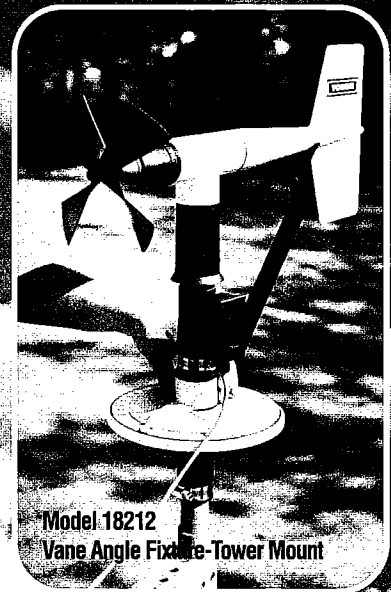
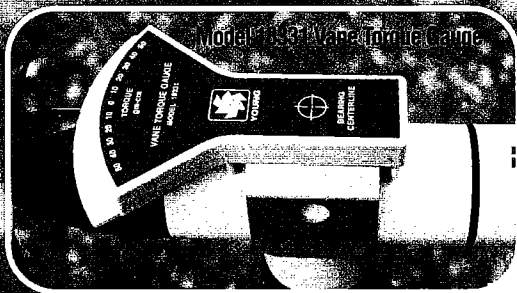
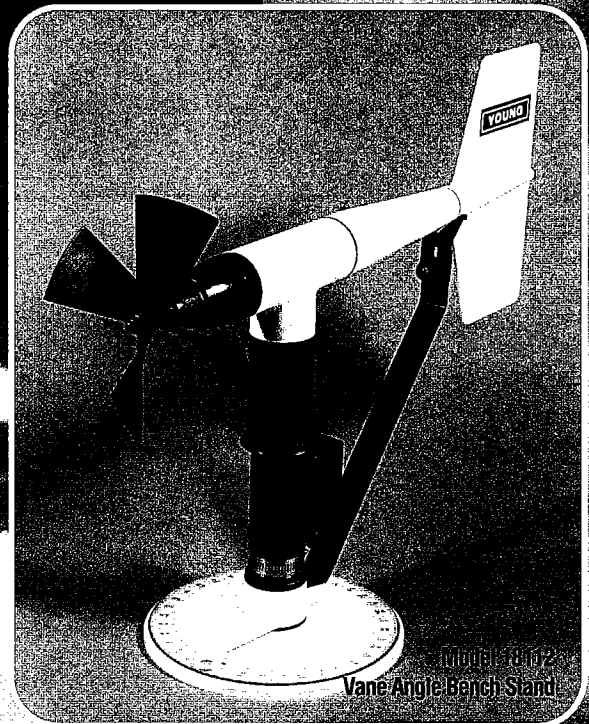
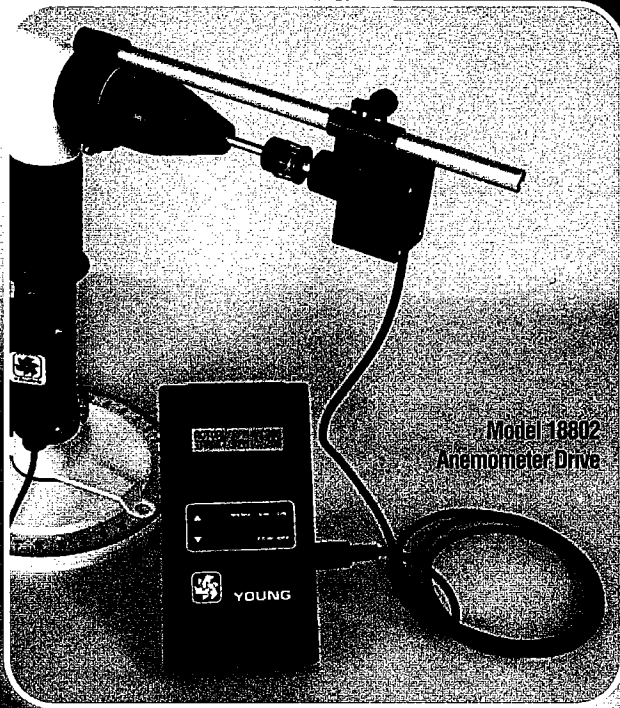

**Model 18802 Anemometer Drive** provides a convenient and accurate way to rotate an anemometer shaft at a known rate. The motor may be set to rotate clockwise or counter-clockwise at any rate between 200 and 15,000 RPM in 100 RPM increments. The LCD display is referenced to an accurate and stable quartz timebase. For completely portable operation, the unit can be operated on internal batteries. For extended operation, an AC wall adapter is included.

**Model 18811 Anemometer Drive** is identical to Model 18802 except the drive motor incorporates a gear reducer for operation in the range of 20 to 990 RPM in 10 RPM increments. The lower range is recommended for cup anemometer calibration.

**Model 18112 Vane Angle Bench Stand** is used for benchtop wind direction calibration of the Wind Monitor family of sensors. The mounting post engages the direction orientation notch on the Wind Monitor. An easy to read pointer indicates 0 to 360 degrees with 1/2 degree resolution.

**Model 18212 Vane Angle Fixture - Tower Mount** similar to the Model 18112, the tower mount feature allows use on the tower as well as the bench top. The fixture is temporarily placed on the tower between the Wind Monitor and its tower mounting. Index keys and notches are engaged to preserve direction reference.

**Model 18310 Propeller Torque Disc** checks anemometer bearing torque with 0.1 gm/cm resolution. The disc temporarily replaces the propeller for torque measurement or simple yet accurate pass/fail checks. Charts included with the unit relate torque to propeller threshold with limits for acceptable bearing performance.

**Model 18312 Cup-Wheel Torque Disc** checks cup anemometer bearing torque.

**Model 18331 Vane Torque Gauge** checks vane bearing torque of the Wind Monitor family sensors. Slip the fixture over the main housing and make simple yet accurate vane torque measurements. Charts relating vane torque to vane threshold provide limits for acceptable bearing performance.

**Model 18301 Vane Alignment Rod** helps align the vane of a wind sensor to a known direction reference during installation. The base of the device has an index key that engages the direction orientation notch in the sensor allowing the sensor to be removed without losing wind direction reference.

Ordering Information	MODEL
ANEMOMETER DRIVE 200 to 15,000 RPM .....	18802
ANEMOMETER DRIVE 20 TO 990 RPM .....	18811
230V / 50-60 HZ INPUT POWER .....	ADD SUFFIX "H"
VANE ANGLE BENCH STAND .....	18112
VANE ANGLE FIXTURE - TOWER MOUNT .....	18212
PROPELLER TORQUE DISC .....	18310
CUP-WHEEL TORQUE DISC .....	18312
VANE TORQUE GAUGE .....	18331
VANE ALIGNMENT ROD .....	18301

## Specifications

### MODEL 18802 ANEMOMETER DRIVE (Replaces 18801)

**Range:**  
200 to 15,000 RPM in 100 RPM increments

**Rotation:**  
Clockwise or Counter-Clockwise

**Display Resolution:**  
1 RPM

**Quartz Timebase Reference:**  
0.1 RPM

**Power Requirement:**  
2x9 V (alkaline or lithium) batteries  
115 VAC wall adapter included  
(230 VAC - add suffix H)

### MODEL 18811 ANEMOMETER DRIVE (Replaces 18810)

**Range:**  
20 to 990 RPM in 10 RPM increments

**Display Resolution:**  
0.1 RPM

### MODEL 18112, 18212 VANE ANGLE CALIBRATION DEVICES

**Range:**  
0 to 360 degrees

**Resolution:**  
0.5 degree

### MODEL 18310, 18312 TORQUE DISC DEVICES

**Range:**  
0 to 5.4 gm-cm

**Resolution:**  
0.1 gm-cm

### MODEL 18331 VANE TORQUE GAUGE

**Range:**  
0 to 50 gm-cm

**Resolution:**  
5 gm-cm

*Specifications subject to change without notice.*



**R.M. YOUNG COMPANY**  
2801 Aero Park Drive  
Traverse City, Michigan 49686 USA  
TEL: (231) 946-3980 FAX: (231) 946-4772  
E-mail: met.sales@youngusa.com  
Web Site: www.youngusa.com